



SLAB
SYSTEM



INDEX

			06-07	
HANDLING		01		08-11
		02		12-15
		03		16-19
		04		20-23

CUTTING		05		24-27
		06		28-31
INSTALLATION	ACCESSORIES	07		32-45
	STEP BY STEP			46-49
	FORMATS			50-51

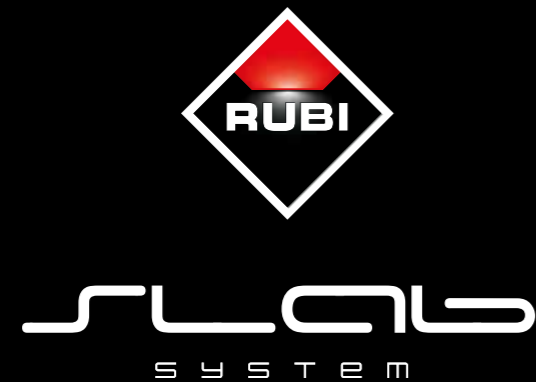

WHO ARE WE?

Germans Boada began almost 70 years ago in the town of RUBI (Barcelona) following the invention of the first manual hydraulic mosaic cutter, an invention that revolutionized the construction sector worldwide. Today Germans Boada is a global company consisting of 11 subsidiaries and 3 production centers around the world and recurring sales to more than 120 countries on 5 continents. Internationally recognized as an innovative brand, RUBI is a leader in the ceramic tile tool sector. With 58 patented products, the RUBI brand has a clear technological leadership thanks to its firm commitment to research, innovation and design. Thanks to this technological capacity, RUBI products help to define the quality standards of the market.

SLAB SYSTEM

At RUBI we are constantly developing new solutions for the professional. An example of this is the SLAB SYSTEM range, which has been specially designed to address large format ceramic installation projects with the maximum guarantee of safety and efficiency for the professional.



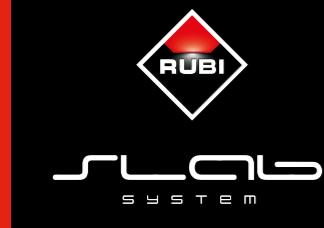

SLAB TRANS HEAVY DUTY

TRANSPORT AND HANDLING SYSTEM FOR LARGE
FORMATS

The Slab Trans Heavy Duty transport system is specially designed for handling large format ceramic sheets and tiles up to 360 cm x 160 cm. It consists of a set of two extruded, reinforced, retractable and adjustable aluminium profiles from 170 to 380 cm, and two perpendicular crossbars that favor the robustness and stability of the whole set, especially during the handling of the heavier parts. It has 6 vacuum suction cups that are easily positionable and allow to adjust the fixing points for safe handling of large format sheets.

The set has 4 handles (2 per guide) that can be adjusted and positioned throughout the length of the guide, making it easy for adapting the Slab Trans Heavy Duty to every situation and format. With a bold and innovative anodized black design, Slab Trans Heavy Duty consists of a set of two profiles in extruded aluminum that give it a maximum load capacity of up to 140 kg. Compatible with the Slab Trolley (Ref. 18934).





SLAB TRANS
PROFESSIONAL
HEAVY DUTY



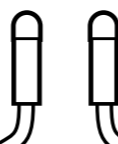

1 
EASY FIXATION

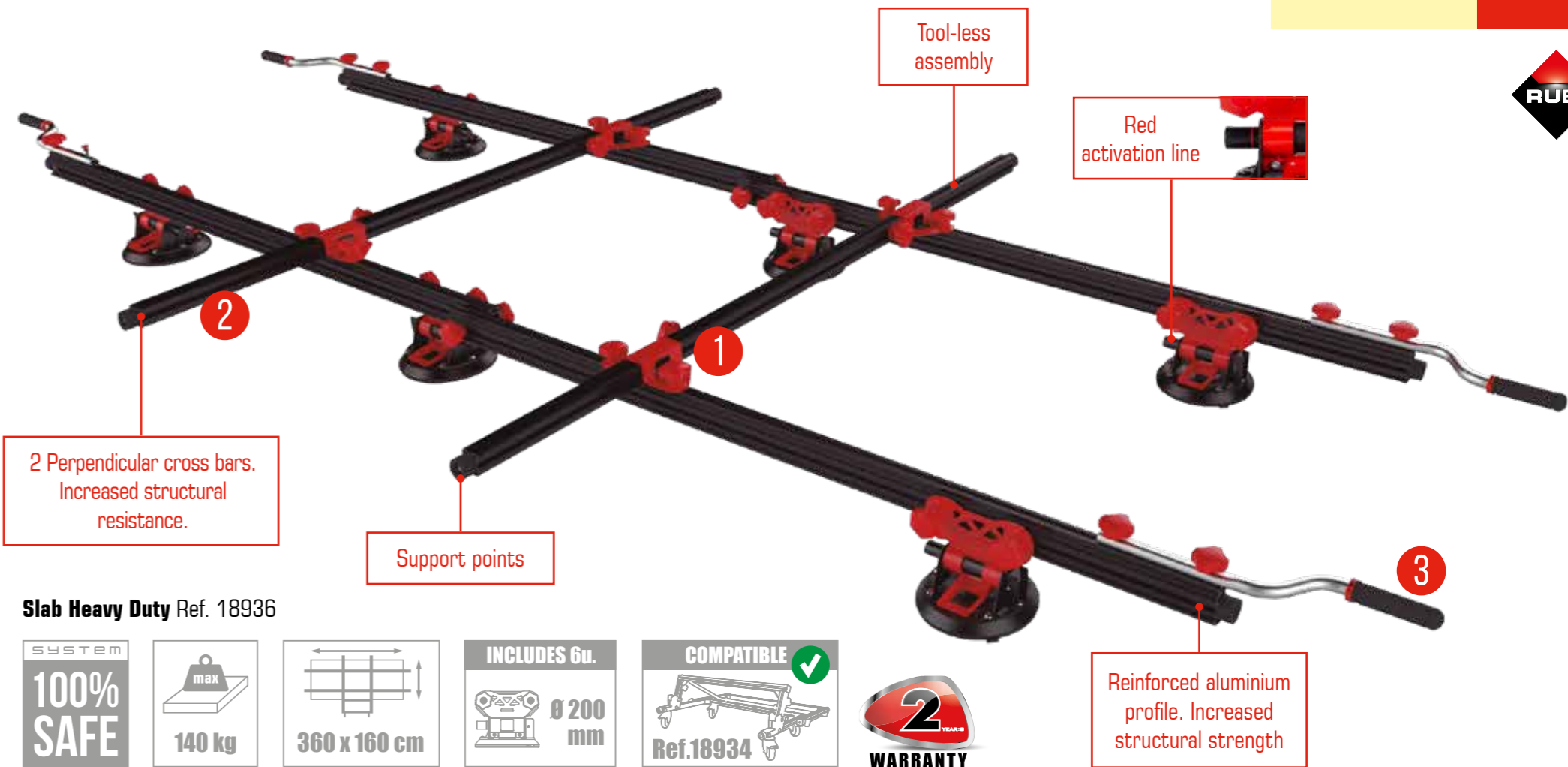
2 
EASY HANDLING

3 
ERGONOMIC

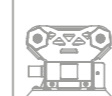

Slab Heavy Duty Ref. 18936

SYSTEM 100% SAFE	 max 140 kg	 360 x 160 cm	INCLUDES 6u.  Ø 200 mm	COMPATIBLE ✓  Ref.18934	 2 YEARS WARRANTY
----------------------------	---	--	---	---	---

MEASURES:

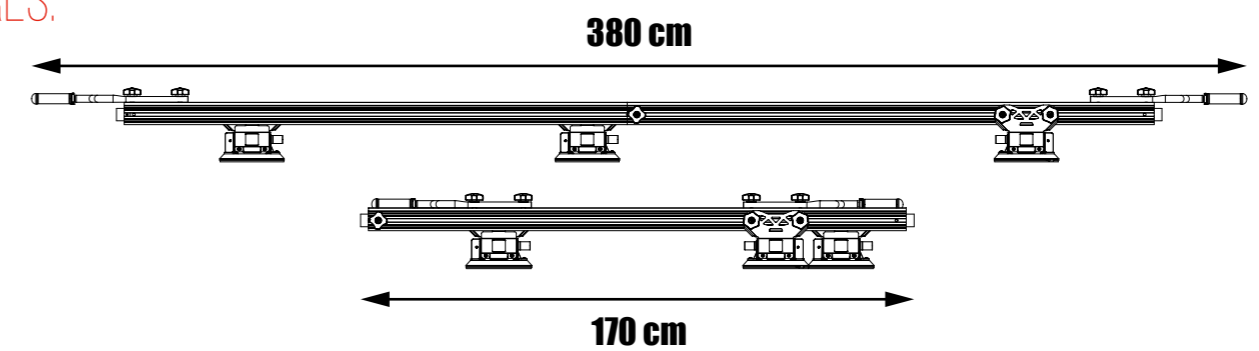

ACCESSORIES:



Suction cup
Ref. 18827



SLAB TROLLEY

TRANSPORT AND MANEUVERING SYSTEM FOR LARGE-FORMAT CERAMICS

Transport and maneuvering system of the Slab System range, for large format ceramic sheets.

It is designed to complement our Slab Trans Heavy Duty making it as easy as possible to transport and handle large format sheets. Thanks to the Easy Fix system, the Slab trolley allows easy and fast assembly and disassembly of the system.

It is lightweight and compact. Its design ensures that the Slab trolley occupies only the right space along with its reinforced aluminium profiles, which give it great robustness and structural strength with minimal weight.

The RUBI Slab trolley incorporates an extendable arm for easy loading and unloading of the ceramic sheet onto the workbench. With the arm

folded, the Slab trolley allows you to pass through the frame of a standard door without the need for complex or risky manoeuvres, even when loaded with the lifting system and ceramics in its maximum format.

Equipped with four swivel wheels (360o) with Stop&Fix braking and locking system, the Slab trolley increases safety in loading and unloading manoeuvres. With the Slab trolley the user can handle tiles up to 140 kg maximum weight and a format up to 360 cm x 160 cm.

The compatibility of our Slim Easy Trans with the Slab trolley requires the mandatory use of the crossbar set (ref. 18819).

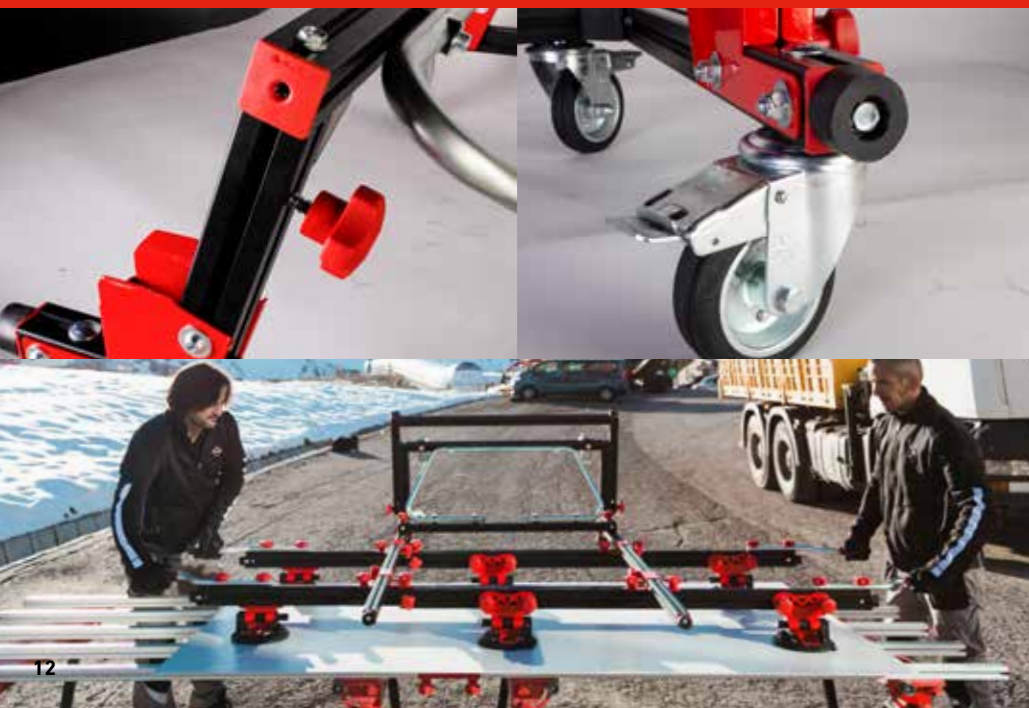

COMPATIBLE SLAB TABLE



1 
EASY FIXATION

2 
EASY MOVEMENT

3 
360° SPIN AND BRAKE

Support points

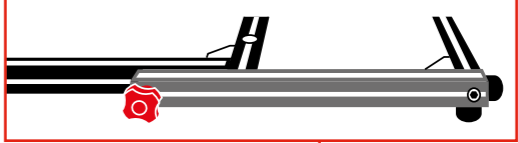

Extendable bar (Compatible with table)



Wheel brake

Trolley Ref. 18934

140 kg

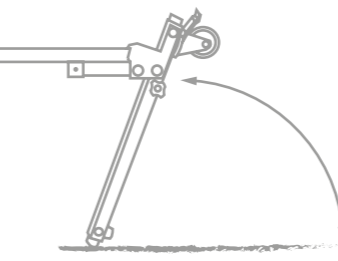
360 x 160 cm

FOLDING

COMPATIBLE 

 Ref.18936

2 YEARS WARRANTY





SLAB TABLE

HANDLING LARGE-FORMAT CERAMICS

Workbench for cutting and handling large format ceramic sheets. With the Easy Fix connection system the assembly and disassembly of the Slab table is very easy and fast. The extra-reinforced aluminium bars give the Slab table a high rigidity and great stability, giving it a maximum load capacity of up to 250 kg. The separation of its 5 aluminum bars allows the user to make perforations and cuts without fear of damaging the table itself. The structure of the Slab table together with the leveling feet achieve greater stability of the whole set. The folding legs

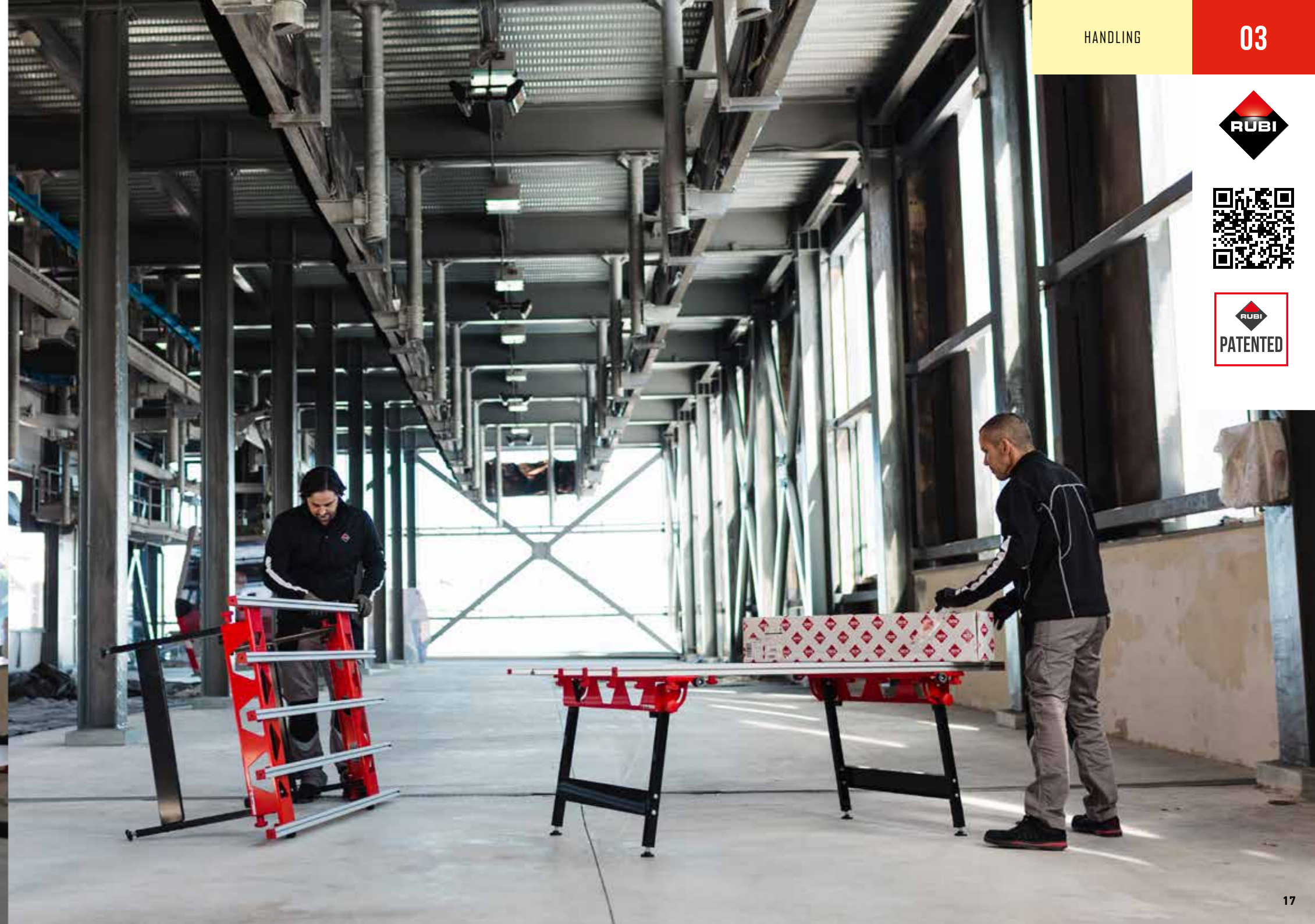
have a safety system that prevents the unintentional closure of the legs. With folded legs the Slab table is less than 20 cm high, so it can be easily stored. The working height of the table is 70 cm to increase ergonomics in all loading and unloading manoeuvres of the material and makes it compatible with our Slab Trolley (Ref. 18934). A Slab table has a length of 180 cm and a width of 104 cm, includes a connector with Easy Fix system that allows the union of two tables and form an ideal work surface for large format ceramic up to 360 cm.





SLAB
TABLE
PROFESSIONAL

1

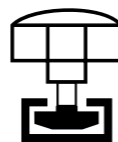

EASY FIXATION

2

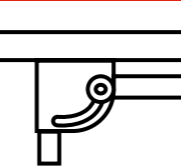

SECURITY SYSTEM

3



REINFORCED



Special height to reduce effort

Support points

Tool-less assembly

Height adjustable legs

Table Ref. 18935

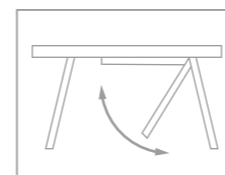

max
250 kg



MEASURES:

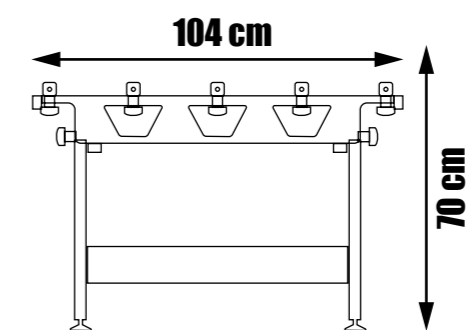
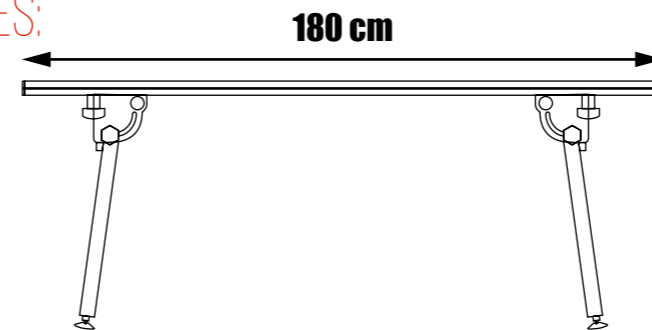

ACCESSORIES:

Fixer to join tables





SLIM EASY TRANS

TRANSPORT AND HANDLING SYSTEM FOR LARGE FORMATS UP TO 60 KG

The Slim Easy Trans transport system is specially designed for handling large format thin porcelain sheets up to 320 cm in length. It consists of a set of two extruded, retractable and adjustable aluminium guides from 160 to 320 cm. It is composed of 10 clamping suction cups for proper system fixation. We must check that the surface of the sheet is clean of dust or other debris for proper operation. Slim Easy Trans suction cups adapt to both smooth surfaces and rough or slightly structured surfaces. The set has 4 handles (2 per guide) that can be adjusted and positioned throughout the length

of the guide, facilitating and adapting the Slim Easy Trans to every situation and format. The load capacity of the assembly is 60 kg. It can be extended up to a maximum of 110 kg, incorporating two suction cups for every 10 kg extra. We can complement our Easy Trans with a crossbar set that will give the system greater stability. Its rubber studs will allow us to support the system and make it compatible with our Slab trolley.

SLIM
PROFESSIONAL
EASY TRANS





SLIM

PROFESSIONAL
EASY TRANS

1 **EASY HANDLING**

2 **ROUGH SURFACES**

3 **SOFTGRIP**

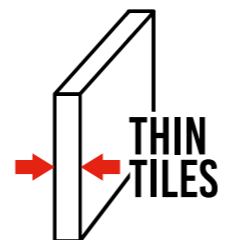

THIN TILES
Slim Easy Trans Ref. 18910

max
60 kg

INCLUDES 10u.
 Ø 120 mm

COMPATIBLE ✓
 Ref.18934 with ref.18819

max.
 320 x 160 cm

2
YEAR WARRANTY

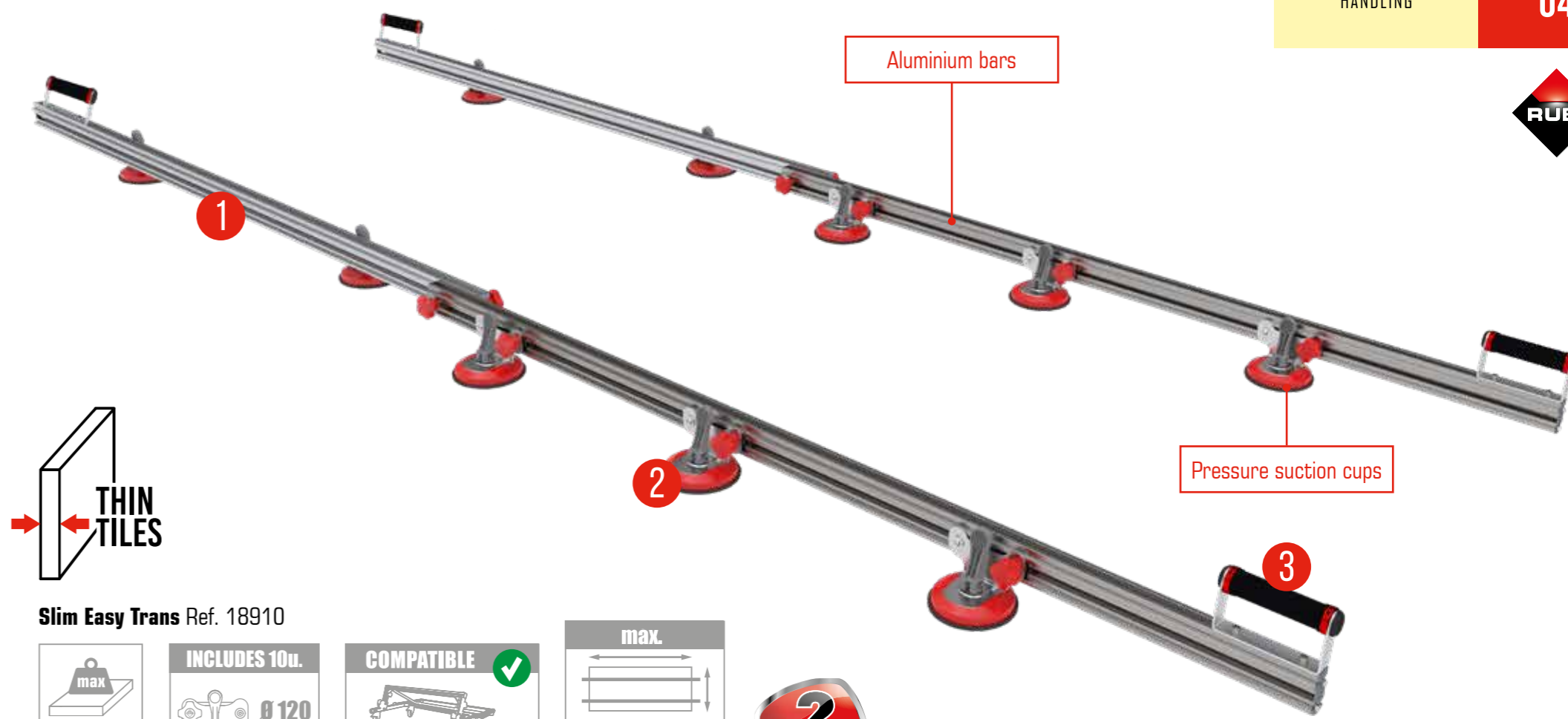

MEASURES:

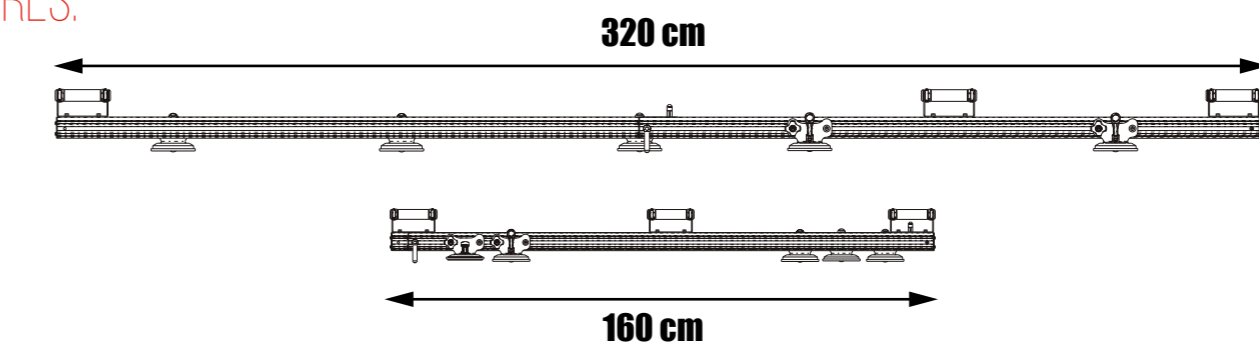

ACCESSORIES:

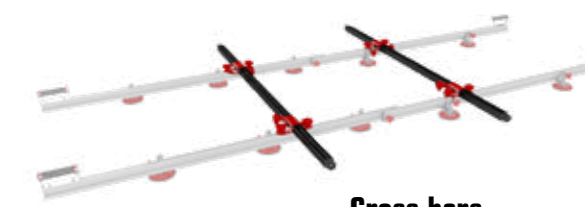

Cross bars
Ref. 18819



SLIM CUTTER

MANUAL CUTTING OF LARGE FORMATS

The Slim Cutter is the most versatile and lightweight on the market. It is a very easy to use cutting system, specially designed for large format tiles.

The entire system is delivered in a practical textile bag with compartments. It consists of 3 guides made of extruded aluminum that are assembled together to ensure perfect scoring in large format sheets up to 320cm, although we can extend the maximum cutting length by adding more guides to the system.

Two suction cups included will help us to fix the guide on the surface of the tile and avoid movement. The

scoring trolley mounts a titanium coated, tungsten carbide Extreme 22 mm scoring wheel, ideal for cutting extreme difficulty materials with rough and structured finishes. The plier ensure that we can separate tiles with thicknesses up to 6 mm after scoring. For tiles with a thickness greater than 6 mm and up to 15 mm, the use of the Slim Separator (ref. 18917) is recommended.

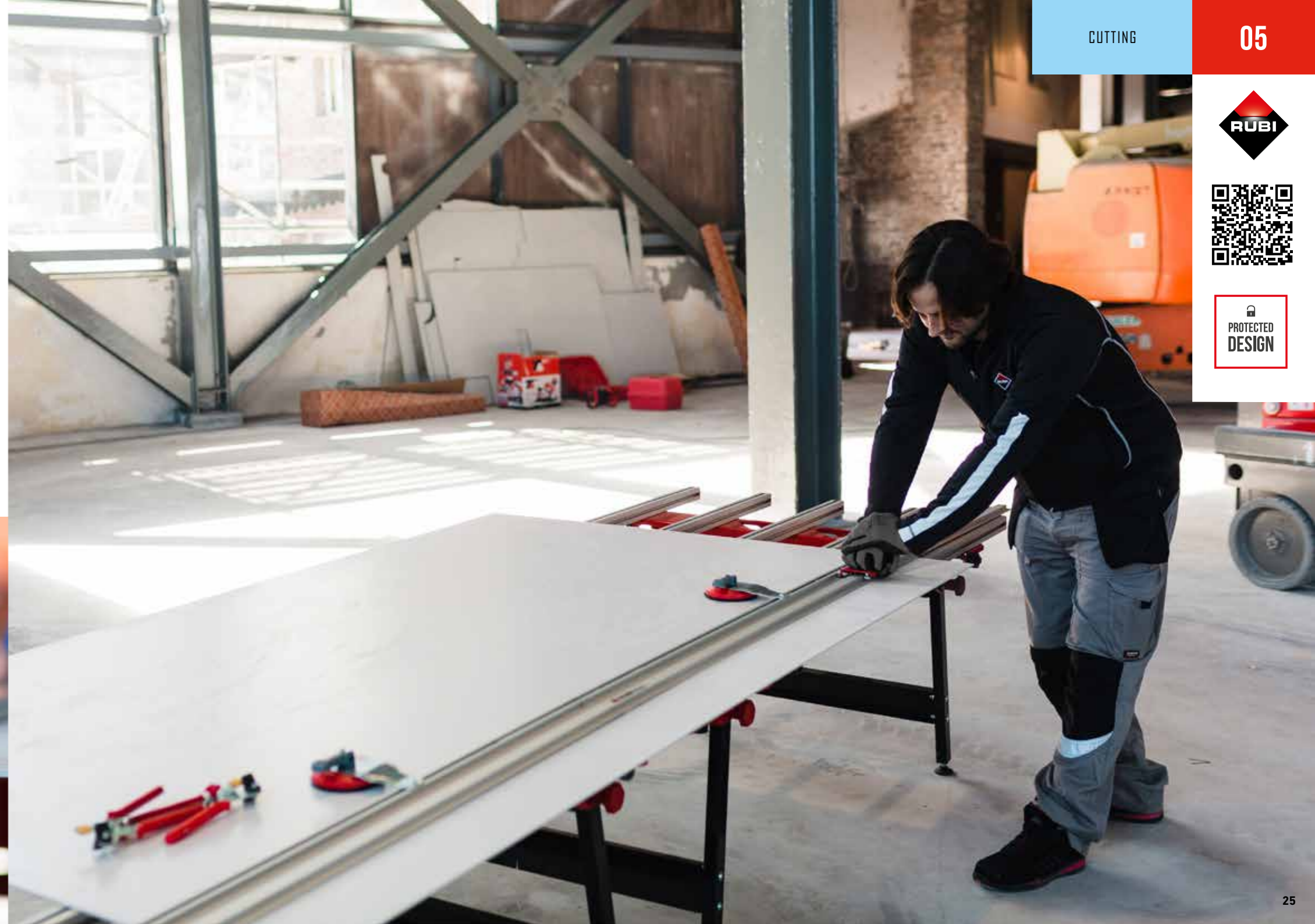



SLIM
CUTTER
PROFESSIONAL

1 **PRECISION**

2 **LIGHT**

3 **BAG INCLUDED**



Suction cups for all surfaces

Extreme scoring wheel included

1.10m extruded aluminium guides

Slim Cutter Ref. 18911

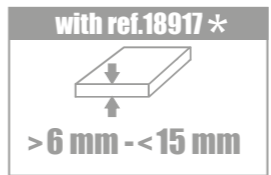
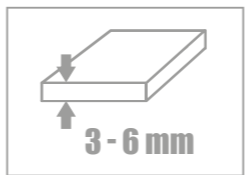
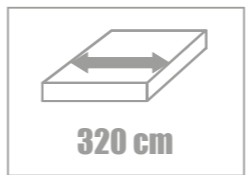

ACCESSORIES:

Supplementary guide
Ref. 18913
Increases cutting length by 110 cm

Slim Separator
Ref. 18917

Extreme scoring wheel
Ref. 01901

Suction cup
Ref. 18957



KIT TC-125

LARGE FORMAT ELECTRIC CUTTER

The TC-125 circular cutter offers a smooth and precise cut ideal for large format ceramics. For the proper operation of the TC-125, it is necessary to use the Slim cutting guides. Thanks to this guidance system, we can obtain a precise and smooth cut. The RUBI TC-125 circular cutter has a dual dust reduction and control system generated during cutting. Either by connecting to a vacuum cleaner (dry cut) or by using water (wet cut).

The head of the TC-125 is foldable up to 45° and height adjustable. In this way, you can inlet and obtain special and more accurate cuts. For miter cutting, the TC-125 includes

an additional ergonomic handle that increases control and visibility during cutting and improves working ergonomics. You can use two disc diameters: 115 and 125 mm.

For the design of the TC-125, the incorporation of disc protector with quick-opening lid has been taken into account, which facilitates disc change and reduces particle projection. In addition to a side protector that improves the performance of dust control system.





1 **SLIM GUIDE**
PRECISION

2 **METAL BALL BEARINGS**
SMOOTH & PRECISE

3 **DUST REDUCTION SYSTEM**

4 **45°**
MITRE CUT

5 **PLUNGE EFFECT**

6 **ERGONOMIC**

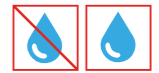

Adjustable fixing along the guide

Splash cap

TCR diamond blade included

KIT TC-125 (230V-50Hz) Ref.51901
KIT TC-125 UK (230V-50Hz) Ref.51902
KIT TC-125 UK (110V-50Hz) Ref.51904

1250 W

Ø 125 mm - 25 mm
Ø 115 mm - 20 mm

Ø 125 mm - 18 mm
Ø 115 mm - 14 mm



ACCESSORIES FOR SLIM CUTTER:



TC-125 230V-50hz - Ref. 50953
TC-125 230V-50hz - Ref. 51959 UK
TC-125 110V-50hz - Ref. 51961 UK



TVA
Ø115mm - Ref. 31932
Ø125mm - Ref. 31933



TVR
Ø115mm - Ref. 30986
Ø125mm - Ref. 30987



ECD
Ø115mm - Ref. 31964
Ø125mm - Ref. 31965



ACCESSORIES

FOR THE CORRECT INSTALLATION OF LARGE
FORMAT CERAMICS

RUBI has the widest range of accessories to successfully complete large format tile installations. Below we present the essential accessories to take into account in this type of projects. Drilling for pipes, drains, fittings, etc. with porcelain-specific bits for tasks that need to be performed in a large format installation. You also have to prepare the piece by making grinder cuts with high quality finishes and handle the sheets by means of suction cups. Cleaning is an essential part of a successful installation.

Proper cleaning of the joint mortar and final cleaning of the work will make our work have the best finish. It is necessary to have a wide range of trowels, to adapt our work to each of the situations required. RUBI leveling systems ensure perfect leveling between parts, saving work in installation and ensuring a perfect finish. The correct choice of the accessories used will give us more performance and workability, directly influencing the final finish.





VACUUM SUCTION CUP

SUCTION CUPS FOR ALL TYPES OF SURFACES

Suction cups for handling large format and heavy weight tiles.
Suitable for any surface finish.
Manual vacuum pump fixing.
Load loss indicator (red mark).
Pressure release mechanism.
Maximum load capacity: 110 kg.

Ref.18919



SUCTION CUPS

SUCTION CUPS FOR ROUGH SURFACES

Suction cups for handling ceramic tiles with rough and/or slightly structured surfaces.

Injected polycarbonate body.

Very light.

Metal reinforcement in lever base for increased tensile strength.

Ergonomic polypropylene handle, for faster and safer handling.

Natural rubber cups.

Cup diameter: 120 mm.

Load capacity: 25 kg.

Double suction cup load capacity: 50 kg.

Ref. suction cup: 66929

Ref. double suction cup: 66952



RUBIMIX

FOR MIXING ADHESIVES

The Rubimix mixer has the main function of mixing correctly and homogeneously the adhesives or resins to achieve greater performance and better grip material workability.

9N

Ref.25940; Ref.24986 (with chuck); Ref.24958 (with carry case).



9N PLUS

Ref.26922

Ref.26924
(with carry case)



16 ERGOMAX

Ref.24994

Ref.24998
(with carry case)

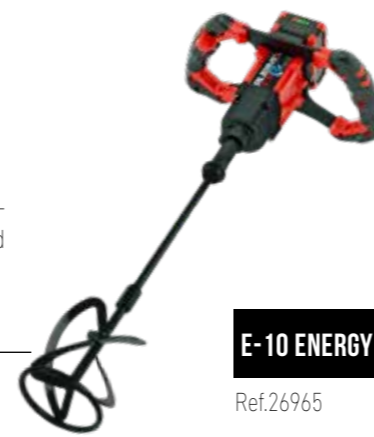

E-10 ENERGY

Ref.26965



SEPARATOR SLIM

SLIM CUTTER ADD-ON

The SLIM separator is the perfect complement to cutting large format sheets with SLIM CUTTER when the sheet thicknesses are equal to or greater than 6 mm up to 15mm. In addition to its main use (large format sheet cutting), the SLIM separator can also be used as an auxiliary separator on large format tiles.

The SLIM separator is equipped with a SOFT-GRIP ergonomic handle to minimize user effort during use.

Ref.18917



KIT DELTA LEVEL SYSTEM

Using a leveling system when placing large format tiles is indispensable. Leveling systems guarantee a perfect finish, eliminating the lips or unevenness between pieces both on the floor and on the wall.



STRIPS

3-12 mm/1mm:
 100 un. Ref.02850
 200 un. Ref.02851
 400 un. Ref.02839
 2400 un. Ref.02870

3-12 mm/1,5mm:
 100 un. Ref.02840
 200 un. Ref.02841
 400 un. Ref.02842
 2400 un. Ref.02855

3-12 mm/2mm:
 100 un. Ref.02852
 200 un. Ref.02853
 400 un. Ref.02854
 2400 un. Ref.02856

6-15 mm/3mm:
 100 un. Ref.02866
 200 un. Ref.02867
 400 un. Ref.02868
 2400 un. Ref.02869

11-20 mm/1,5mm:
 100 un. Ref.02846

11-20 mm/2mm:
 100 un. Ref.02858



WEDGES

 200 un. Ref.02844
 400 un. Ref.02845
 1200 un. Ref.02857

PLIERS

 Ref.03901

KIT

 **1mm** Ref. 03913
1,5mm Ref. 03914
2mm Ref. 03915



LEVELING

FOR THE CORRECT FIXING OF THE CERAMICS

To ensure a correct settlement and level of the tile during installation. Single tapping block. Water-repellent wood with high abrasion resistance. Perfect flatness. Base dimensions: 40x14.5 cm. With white natural rubber sheet to avoid damaging the surface of the tile.

Ref. 72980

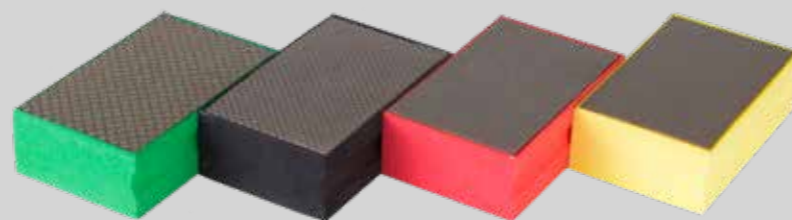

DIAMOND POLISHING BLOCK

EDGE POLISHING

Diamond blocks for rectifying and polishing of edges on cermaic, porcelain and natural stone. It is advisable to use after each manual cut to avoid sharp edges during the handling of the parts.

Grain #60 Ref. 61974; **Grain #120** Ref. 61975; **Grain #200** Ref. 61976; **Grain #400** Ref. 61977.



DIAMOND DISCS

FOR ELECTRIC CUTTING

TVR: Disc specific to hard materials and prepared to withstand high stresses of the disc when cutting. High cutting speed.

TVA: Specific disc for hard materials with a diamond band that offers greater speed without sacrificing the quality of the finish.



ECD DIAMOND DISC

FOR CUTTING AND CUTTING

Recommended for cutting and grinding ceramic and materials such as soft natural stone and ceramic tile. Used for adjustment cuts and high quality finishing. Double-sided with electroplated diamond for maximum use of the disc.



4DRILL DIAMOND DRILLS

FOR DRY DRILLING

Drill bits for dry drilling porcelain stoneware, natural and artificial stone. High quality finishes, suitable for cordless drills from 1000 to 2500 RPM. during use.



EASYGRES DIAMOND DRILLS

FOR WET DRILLING

Drill bits for wet drilling porcelain stoneware, natural and artificial stone. High quality finishes, Suitable for cordless drills from 400 to 1000 RPM during use.



DRYGRES DIAMOND DRILL

FOR WET DRILLING

Bits for use with grinder for dry drilling materials such as ceramics, stoneware and porcelain stoneware. Diameters from 6mm to 75mm with a maximum working speed of 14,000 RPM.



PLAIN AND SERRATED

TROWELS FOR ADHESIVE

Wide range of plains and serrated trowels with Rubiflex or wood handle and a coted steel or INOX stainless steel sheet with high resistance to wear and corrosion.



GROUT FLOATS

FOR TILES

For the grouting of ceramic tiles with comfortable handles and different rubber hardnesses.



TROWELS

FOR ADHESIVE HANDLING

Wide range of trowels for all uses, with Rubiflex or wood handle.



FLEXTUB PLASTIC BUCKETS

40 L.

Wide range of high strength plastic and rubber buckets, versatile and functional. Ideal for use with Rubimixers. Resistant to extreme temperatures and very easy to clean.



RUBICLEAN

FOR A GOOD GROUT FINISH

CLEANING KIT to leave a high quality finish in the grouting and final cleaning of the work..



1

WORK AREA PREPARATION



2

TRANSPORT

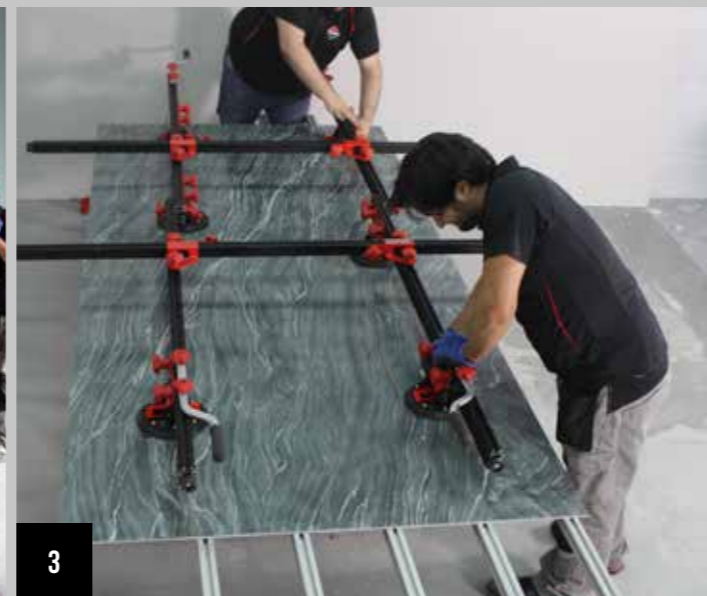

3

HANDLING



4

MANUAL CUTTER



4

ELECTRIC CUTTER



5

WALL ADHESIVE

STEP BY STEP

HOW TO INSTALL LARGE-FORMAT TILES



BACK BUTTERING OF TILES ON THE TROLLEY

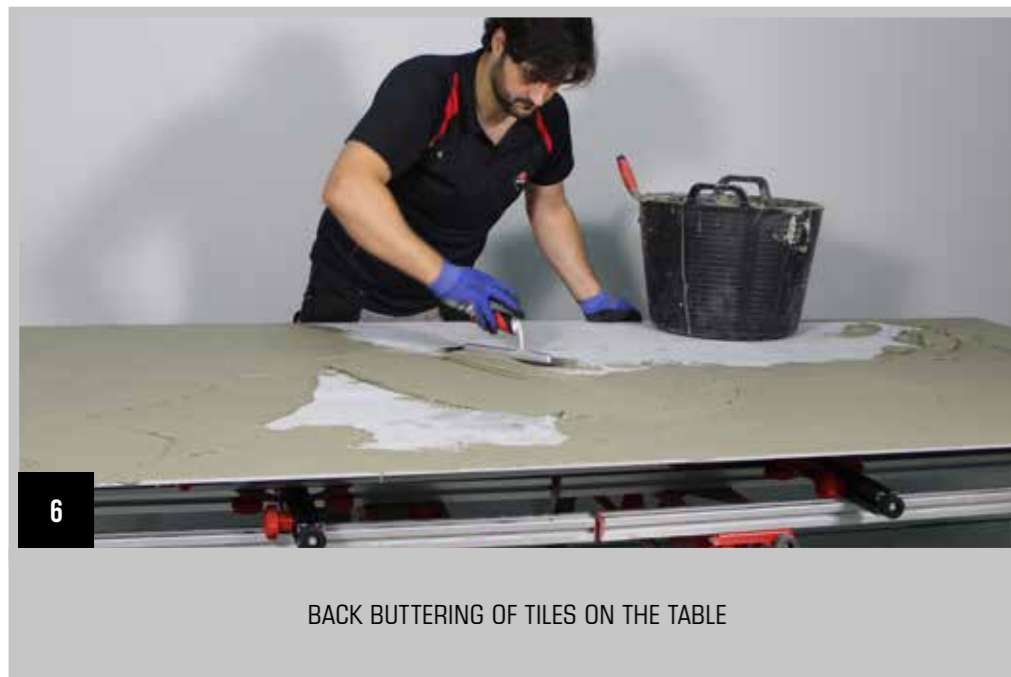

BACK BUTTERING OF TILES ON THE TABLE



TILE PLACEMENT



TILE LEVELING



FIXING TILES



GROUTING AND FINAL CLEANING

FORMATOS

ESPEORES Y FORMATOS

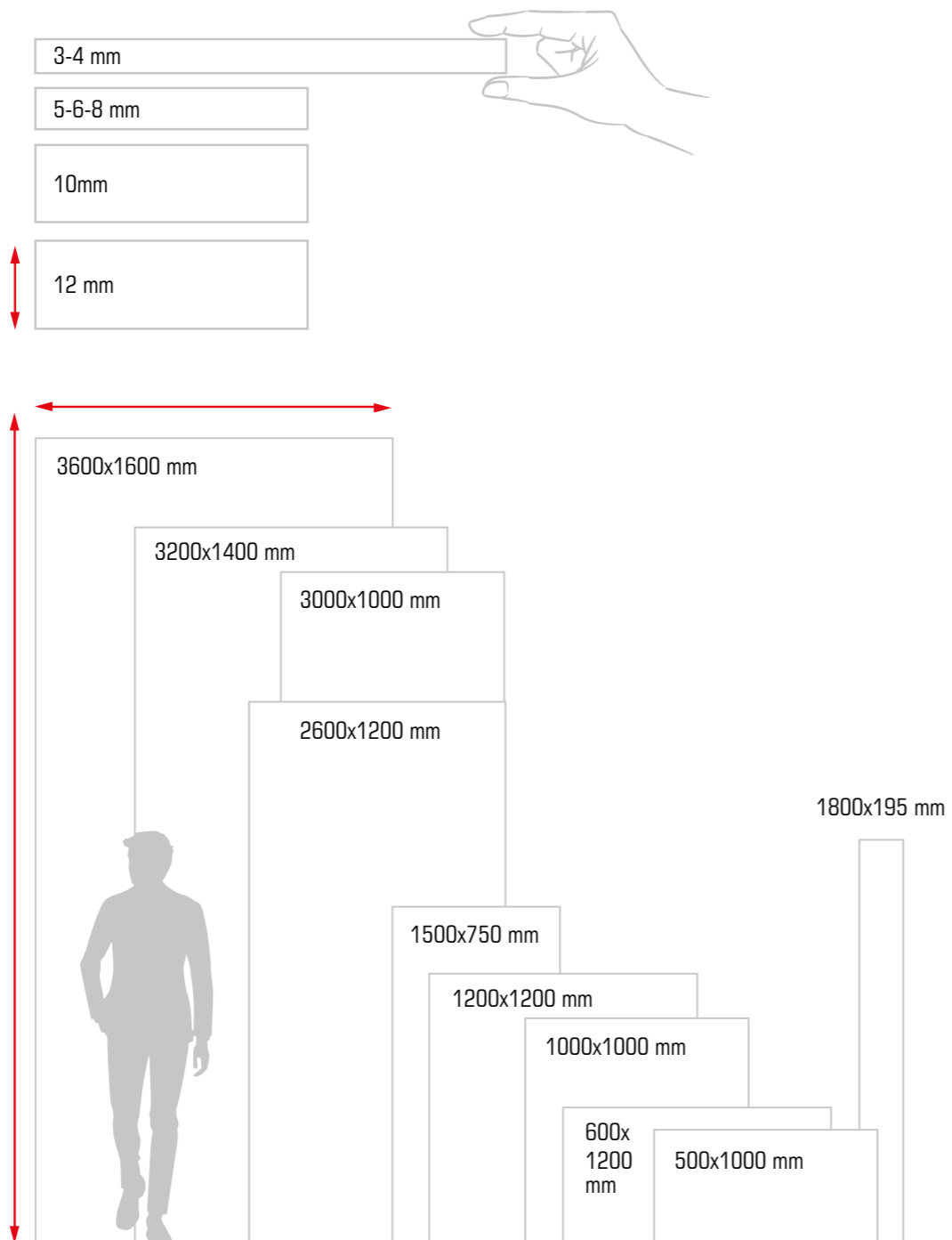

CLUB RUBI APP

WWW.RUBI.COM



REGISTER YOUR RUBI PURCHASES
THROUGH OUR APP AND GET
EXCLUSIVE ADVANTAGES!



Building Together

GERMANS BOADA S.A.

Pol. Can Rosés,
Avda. Olímpiques 89-91, P.O.BOX 14
08191 RUBI (Barcelona) SPAIN
T. 34 936 80 65 00
F. 34 936 80 65 01
gboada@rubi.com

GERMANS BOADA S.A. MADRID

Thomas Edison 4 Bloque 2 Planta 1 Oficina 2110
28521 Rivas Vaciamadrid - SPAIN
T. 34 914 99 48 63
F. 34 914 99 48 70
gboada.madrid@rubi.com

PT **LUSARUBI Lda.**
Rua da Ribeira de Eiras, S/N
Ponte de Eiras
3020-324 Coimbra - PORTUGAL
T. 351 239 492 430
F. 351 239 492 431
lusarubi@rubi.com

FR **RUBI FRANCE S.A.R.L.**
Immeuble Oslo
19 Avenue de Norvège
91953 LES ULIS - FRANCE
T. 33 1 69 18 17 85
F. 33 1 69 18 17 89
rubifrance@rubi.com

US **RUBI TOOLS USA Inc.**
3980 W 104th St, Hialeah,
FL 33018
P. 1 305 715 9892
F. 1 305 715 9898
rubitools.usa@rubi.com

CA **RUBI CANADA**
T. 1 866 872 7824
F. 1 305 715 9898
rubicanada@rubi.com

RU **RUBI ROSSIA**
mob. +7 903 153 30 46
tel.: +34 936806500
факс: +34 936806501
rubirossia@rubi.com

TR **RUBI TÜRKİYE**
Demir Makine Ticaret Ve Sanayi Ltd. Şti.
Emekyemez Mah. Tersane Cd. No.114
Karaköy / İstanbul - Türkiye - Turkey
T. (212) 237-2224
F. (212) 237-2252
rubiturkiye@rubi.com

DE **RUBI DEUTSCHLAND GmbH**
Krahnendonk 89
41066 Mönchengladbach
DEUTSCHLAND
T. 49 (0) 2161 478 12 60
F. 49 (0) 2161 478 12 69
rubideutschland@rubi.com

NL **RUBI BENELUX BV.**
Weidehek, 70
4824 AS BREDA
NEDERLAND
T. 31 (0) 76 57 29 200
F. 31 (0) 76 57 20 190
rubibenelux@rubi.com

CN **Suzhou Rubi Technologies Co., Ltd.**
Block 2, No.86, Tinghe Road, SIP, Suzhou City, Jiangsu
Province, China
Zip Code: 215121
中国江苏省苏州工业园区亭和路86号2号厂房
苏州瑞比机电科技有限公司
邮政编码: 215121
Tel: 86 512 66626100

IT **ITALIA**
T. 800 788278
F. 800 788279
commerciale@rubi.com

IN **RUBI INDIA**
Andheri Kurla Road, Andheri (East)
Mumbai-400059, India.
T. +91 22 67587457 60
rubiwestindia@rubi.com

MA **RUBI MAROC**
Indusmat S.A.R.L
1075, Bd. Mohamed VI Rés. Fath Zhar
MAGASIN: 103 - Casablanca
Maroc - Morocco
T. +212 22.37.80.22
F. +212 22.97.80.49
rubimaroc@rubi.com

GB **RUBI UK LTD.**
Units 16 & 17, Easter Park,
Ferry Lane
Rainham, Essex
RM13 9BP - UNITED KINGDOM
P. 44 (0) 1708559609
F. 44 (0) 1708553813
rubruk@rubi.com

PL **RUBI POLSKA Sp. z o.o.**
ul. Karczkowska 43
02-871 Warszawa
POLSKA
T. +48 (0) 226 44 51 61
F. +48 (0) 226 44 58 45
rubipolska@rubi.com

MX **GERMANS BOADA MEXICO SA DE CV.**
Av. Industria Moderna #2001 Bodega 82,
El Cerrito, CP 76240,
El marqués, QRO
T. +52 55 5592 4907
T. +52 55 5592 5386
mexico@rubi.com

CO **RUBI COLOMBIA**
Cra. 11a #94-56, Oficina 501
Bogotá D.C. COLOMBIA
T. (+ 571) 749 85 08

CL **RUBI CHILE**
GERMANS BOADA S.A.
Los Militares # 5620, Oficina 1503
Los Condes (Santiago de Chile) CHILE
T. (56-2) 2 933 74 92
rubichile@rubi.com

Ref. 92695



www.rubi.com

